

**GRUPPO ISO:
Valvola a sfera e
servomotori con attacco ISO
a 2 e 3 vie**

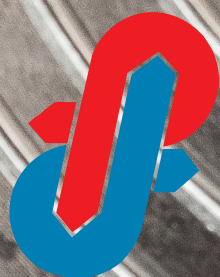

de pala

Italian OEM Technology

Valvole a 2 vie

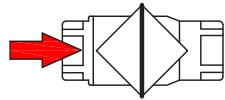
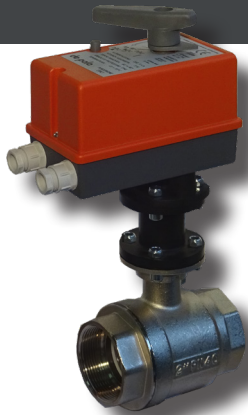

POSIZIONE DI CHIUSURA

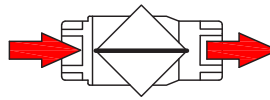

POSIZIONE DI APERTURA

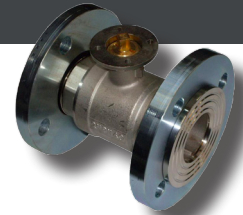

Le valvole pronte da motorizzare sono costituite di ottone nichelato secondo criteri di robustezza ed affidabilità tra i più severi del settore. L'otturatore a sfera garantisce una minima perdita di carico e l'assenza di trafilamento.

ATTACCHI FEMMINA GAS ISO 228-1

FILETTATE	CODICI CORPO VALVOLA								
	632 FI	602 FI	612 FI	622 FI	642 FI	652 FI	662 FI	672 FI	682 FI
DN	15	20	25	32	40	50	65	80	100
ATTACCHI	1/2"	3/4"	1"	1" 1/4	1" 1/2	2"	2" 1/2	3"	4"
F	56	68	78	90	100	115	141	159	195
H1	48	52	56	68	73	79	92	102	129
H2	160	164	168	205	210	216	235	245	272
H3	180	184	188	295	300	306	325	335	362
A	8			10			12		18
COPPIA	4 Nm		5 Nm		6 Nm	7 Nm	15 Nm	18 Nm	
PN	40 bar							25 bar	16 bar
FLANGIA	F03 Q9			F05 Q11			F05 Q14	F07 Q14	
SERVOMOTORI	M7 / R7 / P7 / T7 12 Nm			M8 / R8 20Nm			M9 / R9 50 Nm		

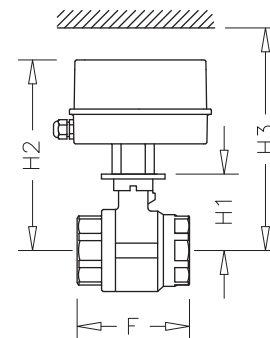
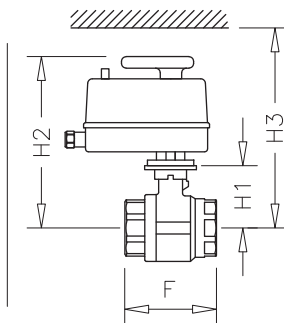
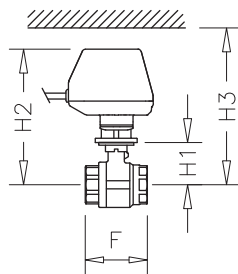
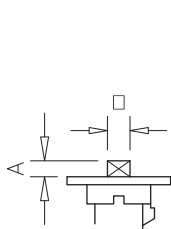

FLANGIA ATTACCO MOTORE ISO 5211

	F03	F05	F07
Di	Ø25	Ø35	Ø55
De	Ø50	Ø65	Ø90
Df	Ø36	Ø50	Ø70
Fori	Ø5.5	Ø6.5	Ø8.5

FLANGIATE	CODICI CORPO VALVOLA				
	642 FL	652 FL	662 FL	672 FL	682 FL
DN	40	50	65	80	100
F	146	167	190	214	254
H1	114	131	92	103	127
H2	251	268	235	246	270
H3	341	358	325	336	360
A	10	10	14	14	17
D1	Ø150	Ø165	Ø185	Ø200	Ø220
D2	Ø110	Ø125	Ø145	Ø160	Ø180
COPPIA	6 Nm	7 Nm	15 Nm	18 Nm	
PN	16 bar				
FLANGIA	F05 Q11		F05 Q14	F07 Q14	
SERVOMOTORI	M8 / R8 20 Nm		M9 / R9 50 Nm		



DIAGRAMMA PERDITE DI CARICO



FLANGE LIBERE ENI 092-1 PNI 6

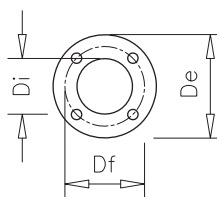
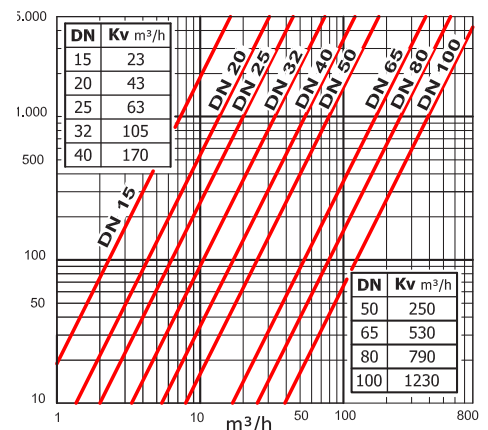
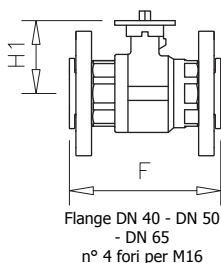

Le quote non indicate corrispondono a quelle delle versioni filettate

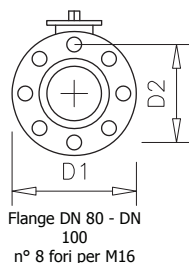

Valvola complanare a 3 vie e 3 fori

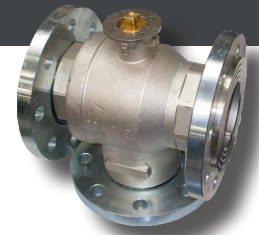
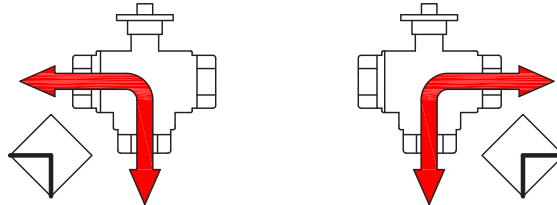
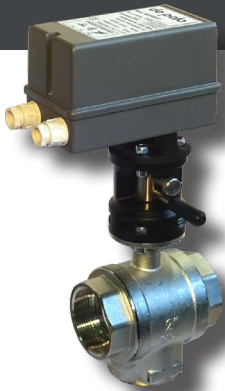

Le tre vie possono essere scelte, secondo le proprie esigenze, a geometria frontale o complanare adattandosi alle più svariate configurazioni impiantistiche.

ATTACCHI FEMMINA GAS ISO 228-1

FILETTATE	CODICI CORPO VALVOLA						
	633 TI	603 TI	613 TI	623 TI	643 TI	653 TI	673 TI
DN	15	20	25	32	40	50	80
ATTACCHI	1/2"	3/4"	1"	1" 1/4	1" 1/2	2"	3"
F	56	68	78	90	100	115	180
P	30	34	41	47	53	62	114
H1	48	52	56	68	73	79	104
H2	160	164	168	205	210	216	247
H3	180	184	188	295	300	306	337
10	8		10			12	
COPPIA	4 Nm		5 Nm		6 Nm	7 Nm	18 NM
PN	25 bar						
FLANGIA	F03 Q9			F05 Q11			F05 Q14
SERVOMOTORI	M7 / R7 / P7 / T7 12 Nm			M8 / R8 20 Nm			M9 / R9 50 Nm

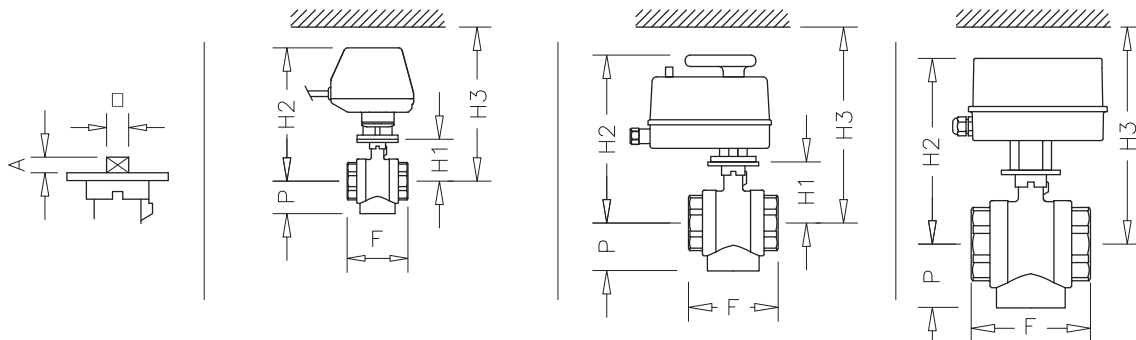

FLANGIATE	CODICI CORPI VALVOLA	
	673 FT	
DN	80	
F	235	
H1	104	
P	140	
H2	247	
H3	337	
A	12	
D1	Ø200	
D2	Ø160	
COPPIA	18 Nm	
PN	16 bar	
FLANGIA	F05 Q14	
SERVOMOTORI	M9 / R9 50 Nm	

FLANGE LIBERE ENI 092-1 PN16

FLANGIA ATTACCO MOTORE ISO 5211

	F03	F05
Di	Ø25	Ø35
De	Ø50	Ø65
Df	Ø36	Ø50
Fori	Ø5.5	Ø6.5



Flange DN 40 - DN 50 - DN 65 n° 4 fori per M16

Le quote non indicate corrispondono a quelle delle versioni filettate

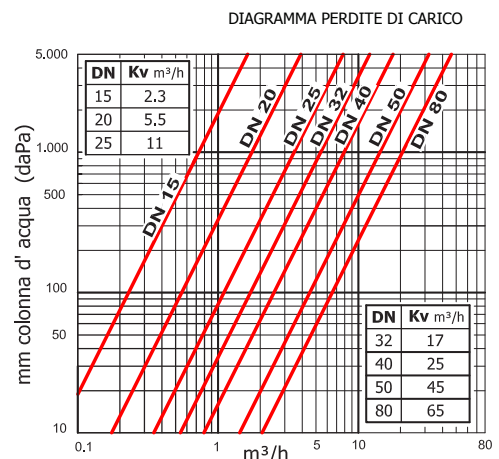

Valvola frontale a 3 vie deviatrice a 2 fori

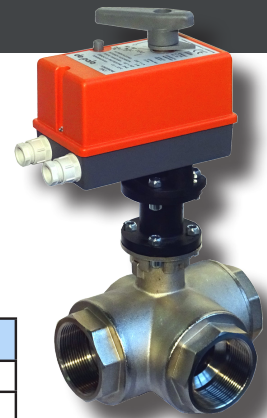
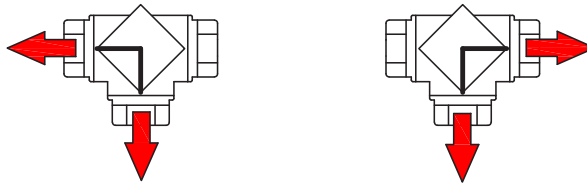

ATTACCHI FEMMINA GAS ISO 228-1

FILETTATE	CODICI CORPO VALVOLA						
	63A LI	60A LI	61A LI	62A LI	64A LI	65A LI	66A LI
DN	15	20	25	32	40	50	65
ATTACCHI	1/2"	3/4"	1"	1" 1/4	1" 1/2	2"	2" 1/2
F	82	90	106	120	142	165	194
H1	51	54	63	67	73	80	91
H2	163	166	200	204	210	217	234
H3	183	186	290	294	300	307	324
A	8		10			12	
COPIA	4 Nm		5 Nm	6 Nm	8 Nm	9 Nm	12 Nm
PN	40 bar						
FLANGIA	F03 Q9		F05 Q11			F05 Q14	
SERVOMOTORI	M7 / R7 12 Nm		M8 / R8 20 Nm			M9 / R9 50 Nm	

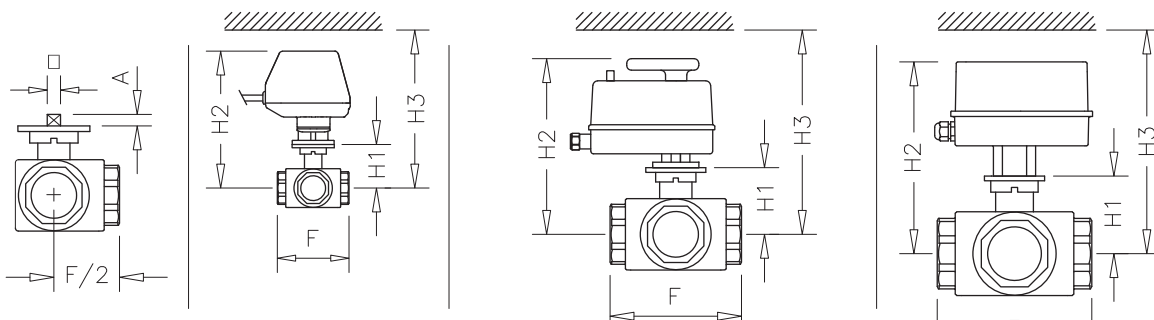

FLANGIA ATTACCO MOTORE ISO 5211

FLANGIATE	CODICI CORPO VALVOLA		
	643 FF	653 FF	663 FF
DN	40	50	65
F	187	215	241
G	116	108	121
H1	73	80	91
H2	210	217	234
H3	300	307	324
A	12		
D1	Ø150	Ø165	Ø185
D2	Ø110	Ø125	Ø145
COPIA	8 Nm	9 Nm	12 Nm
PN	16 bar		
FLANGIA	F05 Q11		F05 Q14

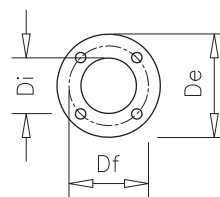

	F03	F05
Di	Ø25	Ø35
De	Ø50	Ø65
Df	Ø36	Ø50
Fori	Ø5.5	Ø6.5

DIAGRAMMA PERDITE DI CARICO

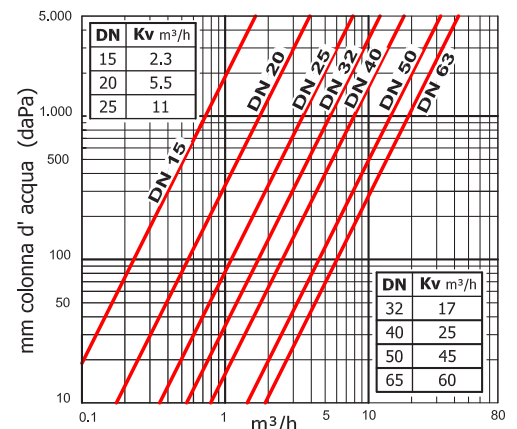

FLANGE LIBERE EN1092-1 PN16

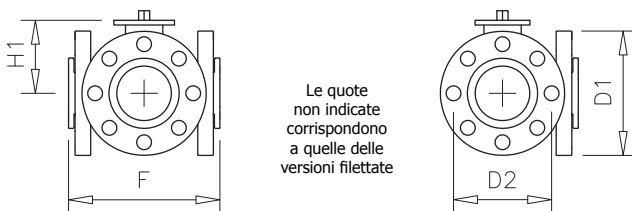

Le quote non indicate corrispondono a quelle delle versioni filettate

Flange DN 40 - DN 50 - DN 65 n° 4 fori per M16

Valvola frontale a 3 vie deviatrice laterale

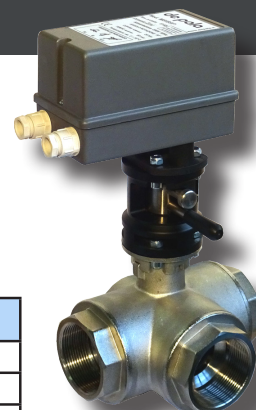
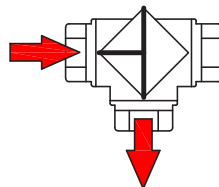
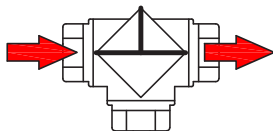

ATTACCHI FEMMINA GAS ISO 228-1

FILETTATE	CODICI CORPO VALVOLA						
	63A TI	60A TI	61A TI	62A TI	64A TI	65A TI	66A TI
DN	15	20	25	32	40	50	65
ATTACCHI	1/2"	3/4"	1"	1" 1/4	1" 1/2	2"	2" 1/2
F	82	90	106	120	142	165	194
H1	51	54	63	67	73	80	91
H2	163	166	200	204	210	217	234
H3	183	186	290	294	300	307	324
A	8		10			12	
COPPIA	4 Nm		5 Nm	6 Nm	8 Nm	9 Nm	12 Nm
PN	40 bar						
FLANGIA	F03 Q9		F05 Q11			F05 Q14	
SERVOMOTORI	M7 / R7 12 Nm		M8 / R8 20 Nm			M9 / R9 50 Nm	

FLANGIA ATTACCO MOTORE ISO 5211

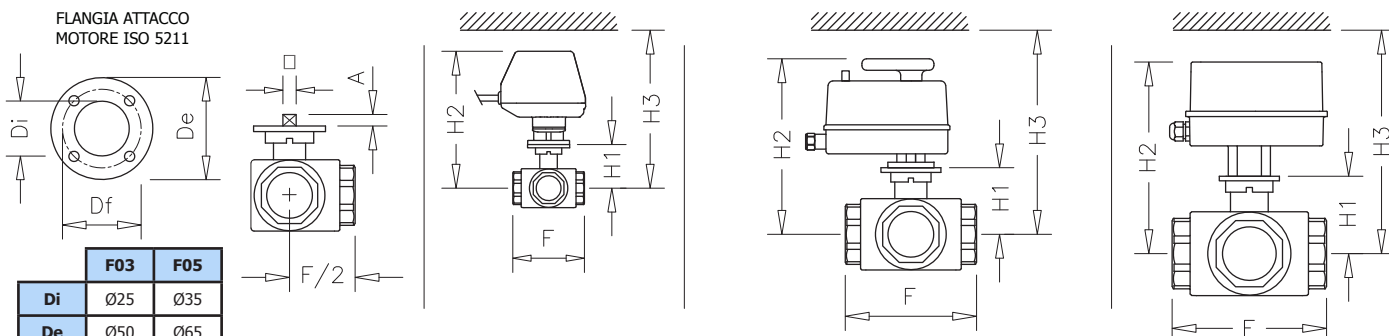

	F03	F05
Di	Ø25	Ø35
De	Ø50	Ø65
Df	Ø36	Ø50
Fori	Ø5.5	Ø6.5

FLANGE LIBERE EN1092-1 PN16

FLANGIATE	CODICI CORPO VALVOLA		
	643 FD	653 FD	663 FD
DN	40	50	65
F	187	215	241
G	116	108	121
H1	73	80	91
H2	210	217	234
H3	300	307	324
A	12		
D1	Ø150	Ø165	Ø185
D2	Ø110	Ø125	Ø145
COPPIA	8 Nm	9 Nm	12 Nm
PN	16 bar		
FLANGIA	F05 Q11		F05 Q14
SERVOMOTORI	M8 / R8 20 Nm		M9 / R9 50 Nm

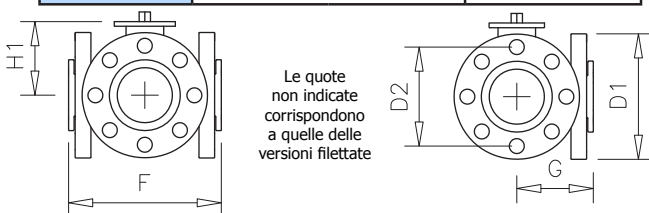

Le quote non indicate corrispondono a quelle delle versioni filettate

Flange DN 40 - DN 50 - DN 65 n° 4 fori per M16

DIAGRAMMA PERDITE DI CARICO

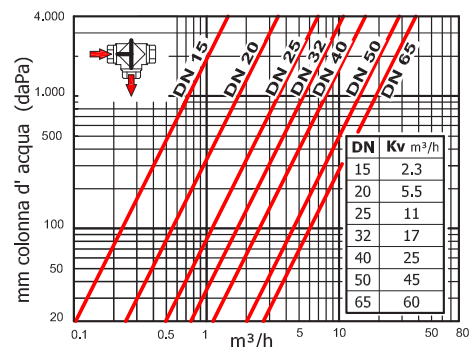
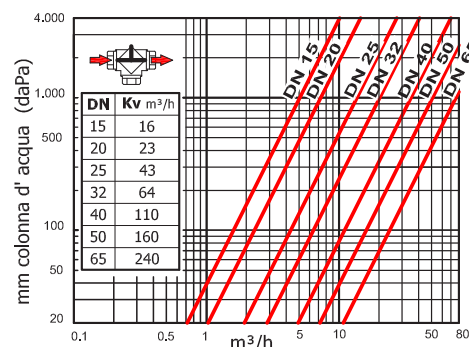

Distanziali

INGOMBRI CON VALVOLE FLANGIATE

DN	40	50
F	146	167
H1	184	201
H2	294	311
H3	384	401

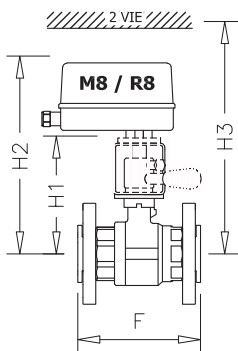

DN	40	50
F	187	215
H1	143	150
H2	253	260
H3	343	350

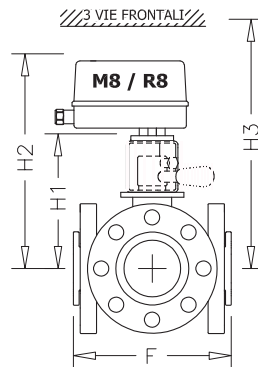

SEMPLICE

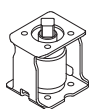

H 70 mm
COD. K9154

DN	65	80	100
ATTACCHI	2" 1/2	3"	4"
F	141	159	195
H1	162	172	199
H2	305	315	342
H3	395	405	432

INGOMBRI CON VALVOLE FILETTATE

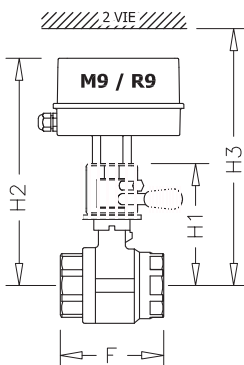

DN	65	80	100
F	190	214	254
H1	162	173	197
H2	305	316	340
H3	395	406	430

3 VIE COMPLANARE

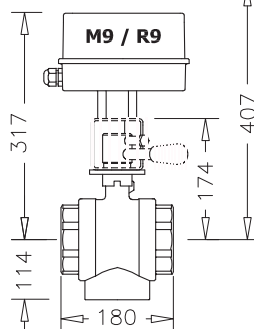

3 VIE FRONTALE

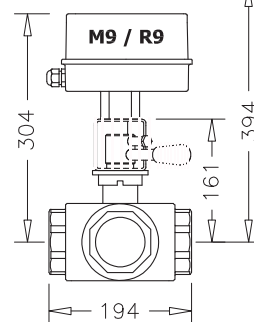

Le prolunghe, realizzate in acciaio inox, permettono di isolare efficacemente il corpo valvola garantendo al servomotore **protezione dalle alte temperature** del fluido convogliato all'interno della valvola. L'isolamento assicura un'ancor più lunga durata del servomotore. Inoltre, nelle versioni dotate di leva è possibile comandare manualmente la valvola **disinnestando il servomotore con pochi facili gesti**.

LA LEVA PER IL COMANDO MANUALE SERVE ANCHE DA INDICATORE DEL FLUSSO (Esempio con valvola a 2 vie)

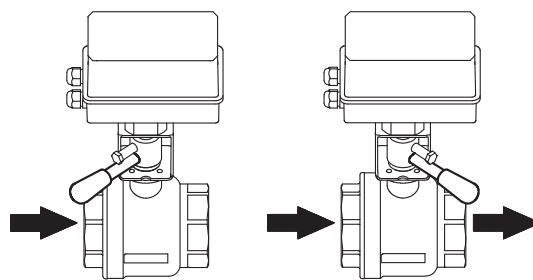

CON LEVA

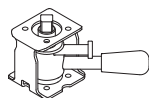

H 70 mm
COD. DMI54

INGOMBRI CON VALVOLE FLANGIATE

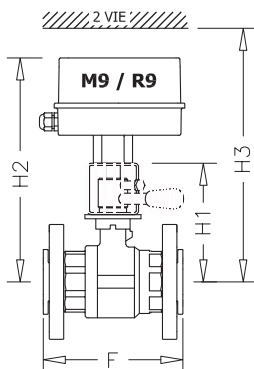

3 VIE COMPLANARE

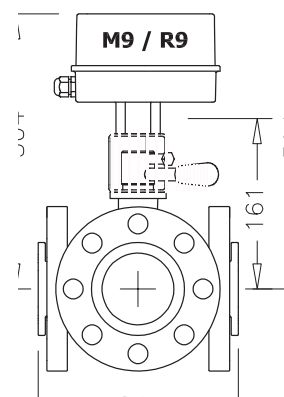
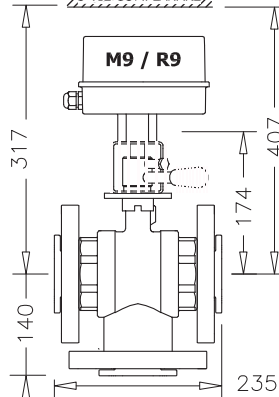

Distanziali

SEMPLICE



DN	15	20	25
ATTACCHI	1/2"	3/4"	1"
F	56	68	78
P	-	-	-
H1	90	94	98
H2	202	206	210
H3	222	226	230

DN	15	20	25
ATTACCHI	1/2"	3/4"	1"
F	56	68	78
P	-	-	-
H1	90	94	98
H2	202	206	210
H3	222	226	230

DN	15	20	25
ATTACCHI	1/2"	3/4"	1"
F	56	68	78
P	30	34	41
H1	90	94	98
H2	202	206	210
H3	222	226	230

DN	15	20
ATTACCHI	1/2"	3/4"
F	82	90
P	-	-
H1	93	96
H2	205	208
H3	225	228



H 42 mm
COD. K3S7

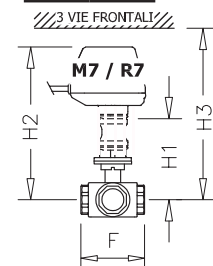
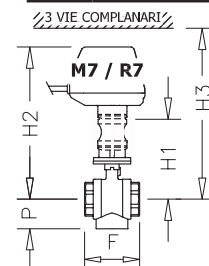
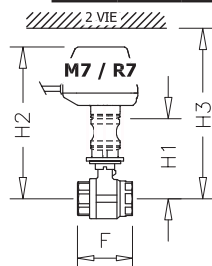

CON LEVA



DN	15	20	25
ATTACCHI	1/2"	3/4"	1"
F	56	68	78
P	-	-	-
H1	124	128	132
H2	236	240	244
H3	256	260	264

DN	15	20	25
ATTACCHI	1/2"	3/4"	1"
F	56	68	78
P	-	-	-
H1	124	128	132
H2	236	240	244
H3	256	260	264

DN	15	20	25
ATTACCHI	1/2"	3/4"	1"
F	56	68	78
P	30	34	41
H1	124	128	132
H2	236	240	244
H3	256	260	264

DN	15	20
ATTACCHI	1/2"	3/4"
F	82	90
P	-	-
H1	127	130
H2	239	242
H3	259	262



H 76 mm
COD. K3M7

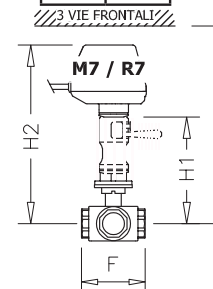
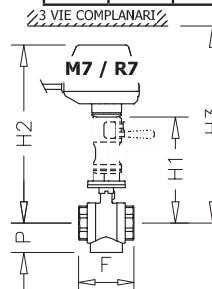
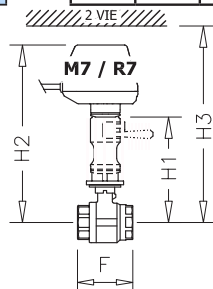

SEMPLICE

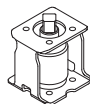

H 70 mm
COD. K8I51

DN	32	40	50
ATTACCHI	1" 1/4	1" 1/2	2"
F	90	100	115
P	-	-	-
H1	138	143	149
H2	248	253	259
H3	338	343	349

DN	32	40	50
ATTACCHI	1" 1/4	1" 1/2	2"
F	90	100	115
P	47	53	62
H1	138	143	149
H2	248	253	259
H3	338	343	349

DN	25	32	40	50
ATTACCHI	1"	1" 1/4	1" 1/2	2"
F	106	120	142	165
P	-	-	-	-
H1	133	137	143	150
H2	243	247	253	260
H3	333	337	343	350

DN	25	32	40	50
ATTACCHI	1"	1" 1/4	1" 1/2	2"
F	106	120	142	165
P	-	-	-	-
H1	133	137	143	150
H2	243	247	253	260
H3	333	337	343	350

CON LEVA



INGOMBRI CON VALVOLE FILETTATE

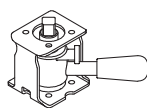

H 70 mm
COD. DMI51

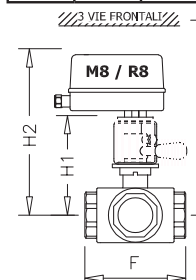
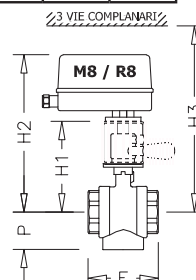
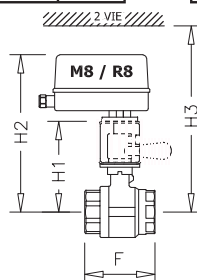

Servomotori

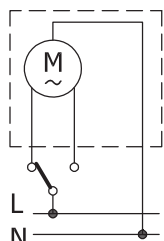

3 FILI

Ogni servomotore va collegato ad un solo comando

BIDIREZIONALI

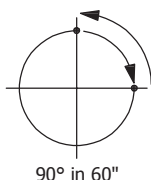

90° in 60"

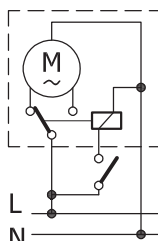

2 FILI

E' possibile collegare più servomotori ad un solo comando

I servomotori comprendono un riduttore con **ingranaggi in acciaio** trattato termicamente e vengono proposti in un'ampia gamma di caratteristiche tecniche per soddisfare ogni esigenza con la migliore soluzione nel migliore dei modi.

M7 • R7 • P7 • T7	CODICE SERVOMOTORI							
	M7IB9	P7IB9	R7IB9	T7IB9	M7IC9	P7IC9	R7IC9	T7IC9
ALIMENTAZIONE	230 Vac +/- 10%				24 Vac +/- 10%			
COMANDO	3 fili		2 fili		3 fili		2 fili	
PROTEZIONE ELETTRICA	IP54	IP65	IP54	IP65	IP54	IP65	IP54	IP65
<p>Altezza 112 Flangia F03 - Q9</p>	Tempo di manovra: 60" x 90° bidirezionale Coppia di spunto: 12 Nm Contatti ausiliari: n°1, portata 6 (2) A - 250 Vac (chiuso con valvola aperta) Temperatura di impiego: 0° ÷ +65° Assorbimento elettrico: 4 W solo durante la manovra Flangia ISO 5211: F03 Q9							
	* Con E al postodi B = 2 contatti ausiliari Esempio: M8IE9				* Con F al postodi C = 2 contatti ausiliari Esempio: M8IF9			

Collegamento elettrico con cavo predisposto



Indicatore di posizione colorato

12 Nm

M8 • R8	CODICE SERVOMOTORI							
	M8IB9	M8IB9P	R8IB9	R8IB9P	M8IC9	M8IC9P	R8IC9	R8IC9P
ALIMENTAZIONE	230 Vac +/- 10%				24 Vac +/- 10%			
COMANDO	3 fili		2 fili		3 fili		2 fili	
PROTEZIONE ELETTRICA	IP42	IP65	IP42	IP65	IP42	IP65	IP42	IP65
<p>Altezza 137 (IP42) Altezza 110 (IP65) Flangia F03 - F05 Q11</p>	Tempo di manovra: 60" x 90° bidirezionale Coppia di spunto: 20 Nm Contatti ausiliari * n°1, portata 16 (6) A - 250 Vac (chiuso con valvola aperta) Temperatura di impiego: -10° ÷ +65° Assorbimento elettrico: 4.5 W solo durante la manovra Flangia ISO 5211: F03 - F05 Q11							
	* Con E al postodi B = 2 contatti ausiliari Esempio: M8IE9				* Con F al postodi C = 2 contatti ausiliari Esempio: M8IF9			

Indicatore di posizione e maniglia per il comando manuale



Pulsante di disinnesto per comando manuale

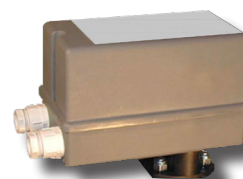

20 Nm

M9 • R9	CODICE SERVOMOTORI			
	M9IB9	R9IB9	M9IC9	R9IC9
ALIMENTAZIONE	230 Vac +/- 10%		24 Vac +/- 10%	
COMANDO	3 fili	2 fili	3 fili	2 fili
PROTEZIONE ELETTRICA	IP65			
<p>Altezza 143 Flangia ISO 5211: F03 Q14</p>	Tempo di manovra: 60" x 90° bidirezionale Coppia di spunto: 50 Nm Contatti ausiliari * n°2, portata 16 (6) A - 250 Vac Temperatura di impiego: 0° ÷ +65° Assorbimento elettrico: 10.5 W solo durante la manovra Flangia ISO 5211: F03 Q14			

Indicatore di posizione



Collegamento a morsettiera

50 Nm